



PREMIER / PREMIER24



CONTROL PANELS:

PR.45E ——— | BRAINY HEADY

PR.45EL ——— | BRAINY HEADY

PR.45E24 ——— | BRAINY24



AUTOMATIONS FOR SWINGING GATES ARTICULATED ARM

personalised release key
up to 4.0 m

ARM NOT INCLUDED



DESCRIPTION

Irreversible geared motor suitable for gates installed on large columns, available in 230 Vac and 24 Vdc versions. Built-in electromechanical open and close limit switches, with sturdy articulated anti-shearing arm in galvanised steel.

230 Vac

- Irreversible 230 Vac electromechanical geared motor also available in the PR.45EL version for large doors

24 Vdc | intensive use

- Irreversible 24 Vdc geared motor for intensive use
- Amperometric sensor obstacle detection system to prevent crushing
- Optional battery powered operation

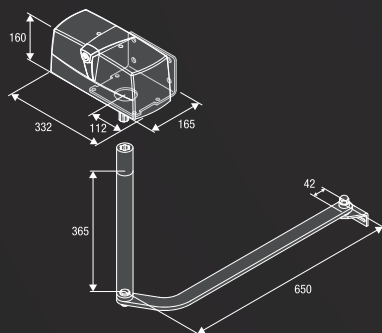
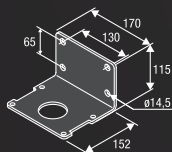

MEASURES

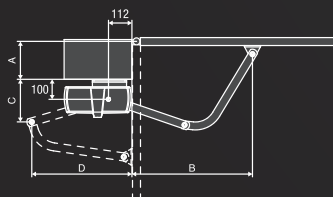

A(mm)	B(mm)	C(mm)	D(mm)
50	883	277	429
150	851	181	466
200	828	117	475
250	800	32	469
300	846	28	468

COMPLETE KITS

KPR 9592073

- 2 PR.45E 230 Vac Operators
- 2 DU.E2 Articulated arms
- 1 HEADY 230 Vac control unit with integrated receiver
- 1 PUPILLA.F Pair of photocells
- 1 LAMPI.LED 230 Vac Led flashing light with built-in aerial
- 1 TOKEY Metal key selector
- 1 TO.GO2WV 433.92 MHz Transmitter

KPR.24 9592074

- 2 PR.45E24 24 Vdc Operators
- 1 BRAINY24 230 Vac control unit with integrated receiver
- 2 DU.E2 Articulated arms
- 1 PUPILLA.F Pair of photocells
- 1 LAMPI24.LED 24 Vdc Led flashing light with built-in aerial
- 1 TOKEY Metal key selector
- 1 TO.GO2WV 433.92 MHz Transmitter

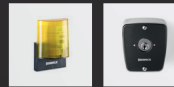



DU.E2
9099011

Single galvanized steel arm for PR.45/PR.45EL/PR.45E24.



MB.SE
9090012

Externally fitted anti-intrusion cable unlock device which allows the gate to be unlocked from outside.



DU.V96
9765035

12 Vac/dc vertical electric lock, supplied with counterplate. Permits internal/external release.



DU.V90
9765030

12 Vac/dc horizontal electric lock, supplied with counterplate. Permits internal/external release.



DU.9990
9623010

Covering plate for DU.V90.



E.LOCK
9765001

230 Vac vertical electric lock, supplied with counterplate.



E.LOCKSE
9765002

Extended cylinder for E.LOCK electric lock. It allows to unlock gates up to 55mm-thick from the outside.



ID.TA
9846019

Warning board.



ESA BASIC
9176108

System that reduces the electrical energy consumption. In the 24 Vdc version, the use of ESA BASIC is not compatible with the battery operation.



KSUN
9611004

KIT for system operation via solar panel. For 24 Vdc models.

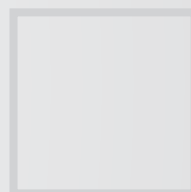
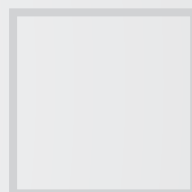
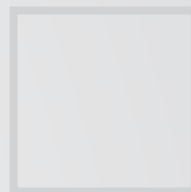
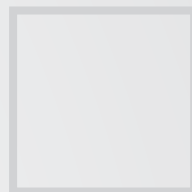

 **MADE IN ITALY**

AUTOMATISMI BENINCA SpA • via del Capitello, 45 • 36066 Sandrigo (VI) ITALY • T +39 0444 751030 • F +39 0444 759728 • sales@beninca.it

TECHNICAL DATA	PR.45E	PR.45EL	PR.45E24
Code	9590684	9590685	9590686
Power supply	230 Vac (50-60Hz)	230 Vac (50-60Hz)	230 Vac (50-60Hz)
Motor supply	230 Vac	230 Vac	24 Vdc
Max absorbed current	1.75 A	1.45 A	9 A
Torque	325 Nm	300 Nm	320 Nm
Opening time	13"	20"	9"
Operation cycle	30%	30%	intensive use
Protection level	IP44	IP44	IP44
Operating temperature	-20°C /+50°C	-20°C /+50°C	-20°C /+50°C
Leaf max dimension	3 m	4 m	3 m
Weight	13 kg	13 kg	13 kg
Items no. per pallet	68	68	68
Kits no. per pallet	12	-	12